

**PRELIMINARY**

# **TOUCAN**



**TOUCAN 861**



**TOUCAN 861**



**TOUCAN 1100**

**TOUCAN 861  
TOUCAN 1100**

[www.jlg.com](http://www.jlg.com)



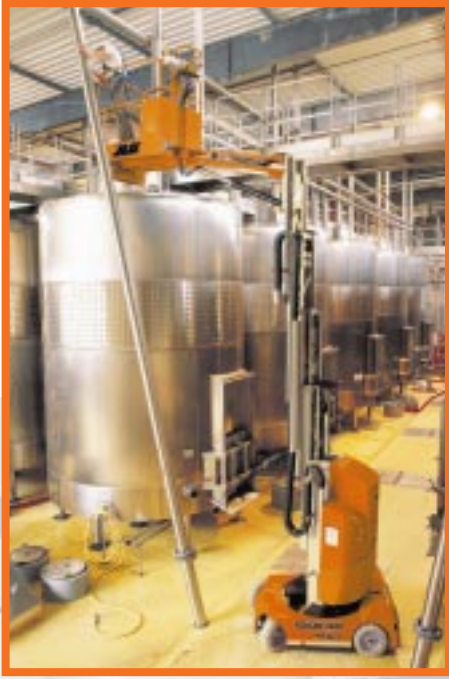

1100



861



861



861



861



861



1100















861



861



861

	861	1100
 <ul style="list-style-type: none"> <li>Working height</li> <li>Hauteur travail</li> <li>Arbeitshöhe</li> <li>Altura trabajo</li> <li>Altezza di lavoro</li> </ul>	8,72 m	11,00 m
 <ul style="list-style-type: none"> <li>Stowed height</li> <li>Hauteur repliée</li> <li>Bauhöhe</li> <li>Alto de plataforma recogida</li> <li>Altezza piattaforma abbassata</li> </ul>	1,99 m	2,19 m
 <ul style="list-style-type: none"> <li>Width</li> <li>Largeur</li> <li>Breite</li> <li>Ancho</li> <li>Larghezza</li> </ul>	0,99 m	0,99 m
 <ul style="list-style-type: none"> <li>Length</li> <li>Longueur</li> <li>Gesamtlänge</li> <li>Longitud chassis</li> <li>Lunghezza chassis</li> </ul>	2,68 m	2,68 m
 <ul style="list-style-type: none"> <li>Outreach with standard or (large platform)</li> <li>Déport avec panier standard ou (grand panier)</li> <li>Seitliche Reichweite Standard Plattform oder (mit grossem korb)</li> <li>Alcance horizontal Plataforma estandar o (con cesta grande)</li> <li>Sbraccio piattaforma standard (con cestello maggiorato)</li> </ul>	3,14 m (3,46 m)	3,30 m (3,60 m)
 <ul style="list-style-type: none"> <li>Weight</li> <li>Poids</li> <li>Eigengewicht</li> <li>Peso</li> <li>Peso</li> </ul>	2980 kg	3500 kg
 <ul style="list-style-type: none"> <li>Standard platform dimension or (large platform)</li> <li>Dimension panier standard ou (grand panier)</li> <li>Abmessungen Standard Plattform oder (mit grossem korb)</li> <li>Dimensiones de la plataforma estandar o (con cesta grande)</li> <li>Dimensioni della piattaforma standard (con cestello maggiorato)</li> </ul>	0,70 x 0,90 m  (1,01 x 0,90 m)	0,70 x 0,90 m  (1,01 x 0,90 m)
 <ul style="list-style-type: none"> <li>Work Platform capacity or (large platform)</li> <li>Capacité de la plate-forme standard ou (grand panier)</li> <li>Plattform Tragfähigkeit oder (mit grossem korb)</li> <li>Capacidad de carga de la plataforma estandar o (con cesta grande)</li> <li>Portata della piattaforma standard (con cestello maggiorato)</li> </ul>	220 kg (200 kg)	200 kg (200 kg)
 <ul style="list-style-type: none"> <li>Stowed speed</li> <li>Vitesse repliée</li> <li>Fahrgeschwindigkeit im einteleskopierten Zustand</li> <li>Velocidad con plataforma recogida</li> <li>Velocità piattaforma abbassata</li> </ul>	0 - 3,5 km/h	0 - 3,1 km/h
 <ul style="list-style-type: none"> <li>Gradeability</li> <li>Pente admissible</li> <li>Steigfähigkeit</li> <li>Pendiente admisible</li> <li>Pendenza superabile</li> </ul>	15%	10%
 <ul style="list-style-type: none"> <li>Slewing</li> <li>Orientation</li> <li>Schwenkbereich</li> <li>Rotación</li> <li>Rotazione</li> </ul>	180°	180°
 <ul style="list-style-type: none"> <li>Max. wind speed for outdoor use</li> <li>Vitesse maxi. du vent en usage extérieur</li> <li>Maximale Windgeschwindigkeit beim Ausseneinsatz</li> <li>Velocidad máxima del viento para un uso exterior</li> <li>Velocità massima del vento con utilizzo in area esterna</li> </ul>	12,5 m/s	12,5 m/s
 <ul style="list-style-type: none"> <li>Turning radius inside/outside</li> <li>Rayon de braquage intérieur/extérieur</li> <li>Wenderadius innen/aussen</li> <li>radio de Giro interior/exterior</li> <li>Raggio di sterzata interno/esterno</li> </ul>	1,02 m/ 2,40 m	1,14 m/ 2,35 m

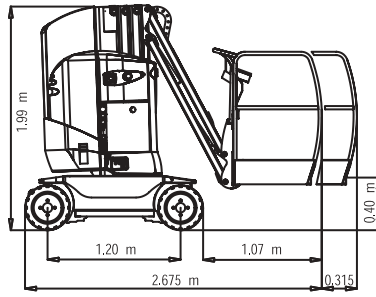
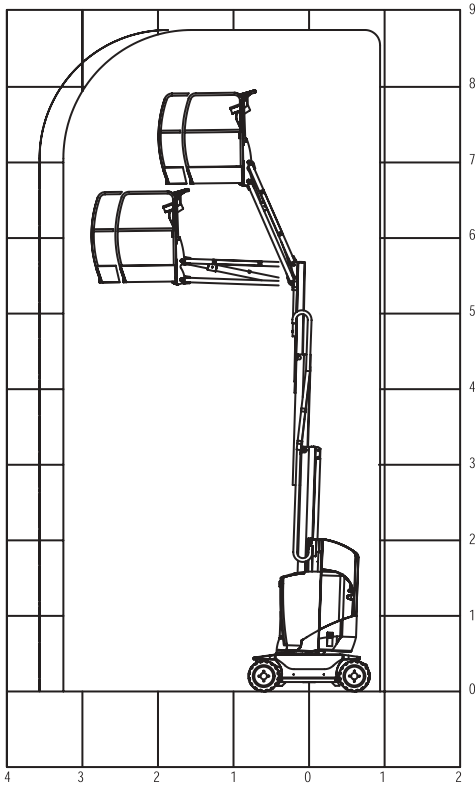

TOUCAN 861

**JLGDANMARK**  
 Tel: +45 (0) 43 54 43 22  
 Rosenvangen 15, 2635 Ishøj, Denmark

**JLGDEUTSCHLAND**  
 Tel: +49 (0) 421 693 500  
 JLG Deutschland GmbH,  
 Max Planck Strasse 21,  
 D-27721 Ritterhude/Ihlpohl (Bei Bremen),  
 Germany

**JLGFRANCE**  
 Tel: + 33 (0) 553 88 31 70  
 Fax: + 33 (0) 553 88 31 79  
 ZI de fauillet  
 47400 TONNEINS, France

**JLGIberICA**  
 Tel: +34 93 772 47 00  
 Plataformas Elevadoras JLG Ibérica,  
 Trapadella 2,  
 Poligono Industrial Castellbisbal Sur,  
 Barcelona, Spain

**JLGIITALIA**  
 Tel: +39 02 9359 5210  
 JLG Industries (Italia) s.r.l.,  
 Via Po, 22,  
 20010 Pregnana Milanese -ML-, Italy

**JLGNORGE**  
 Tel: +47 (0) 66 82 20 00  
 JLG Industries Norge AS,  
 Postboks 525, Sofiemyrveien 12,  
 N-1411 Kolbotn, Norway

**JLGPOLSKA**  
 Tel: +48 (0) 91 43 58 200  
 JLG Polska z.o.o.,  
 Krolewska 27,  
 00-060 Warszawa, Poland

**JLGSVERIGE**  
 Tel: +46 (0) 8 506 59500  
 JLG Sweden AB,  
 Enköpingsvägen 150,  
 Box 704,  
 SE-175 27 Järfälla, Sweden

**JLGUIK**  
 Tel: +44 (0) 870 200 7700  
 JLG Industries (United Kingdom) Limited,  
 Unit 12 Southside,  
 Bredbury Park Industrial Estate,  
 Bredbury Stockport SK6 2SP,  
 United Kingdom

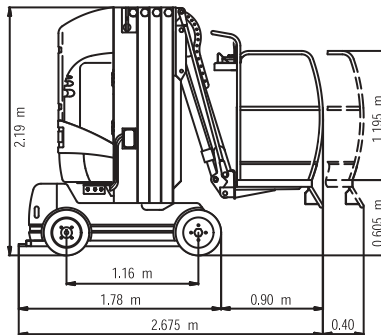
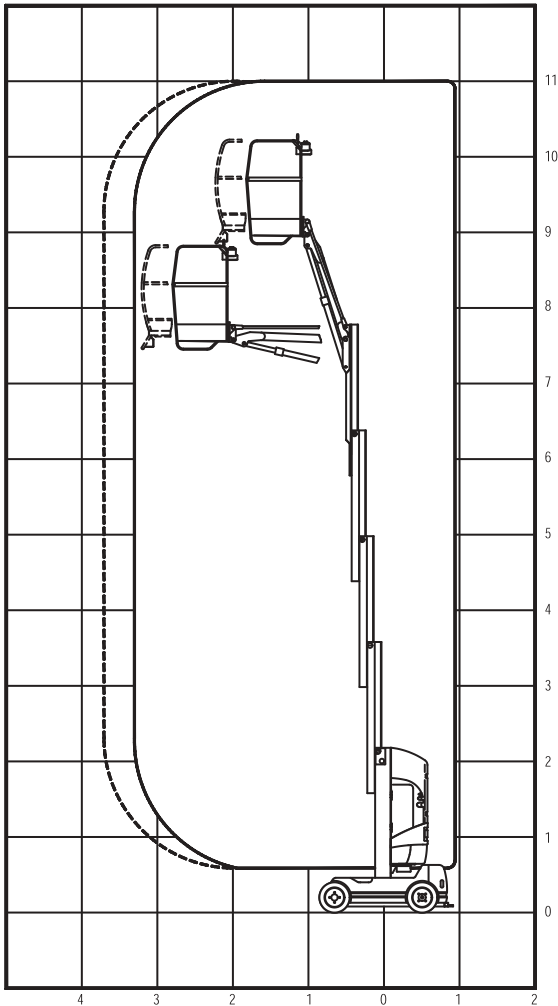

TOUCAN 1100

